

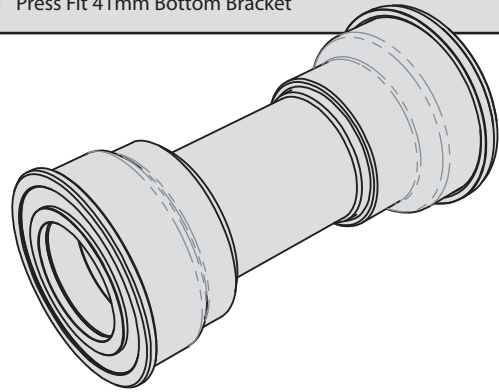

Press Fit 41mm Bottom Bracket



HOPETECHNOLOGY
Hope Mill,
Barnoldswick,
Lancashire,
ENGLAND
BB18 5PX

www.hopetech.com

BBPF41SSN / BBPF41CRN

Tools required:

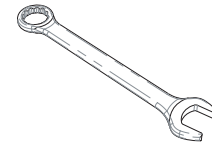

27mm spanner

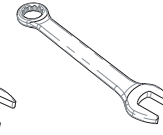

19mm spanner

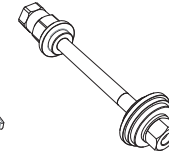

Hope Bottom Bracket Tool (HTTFFA)

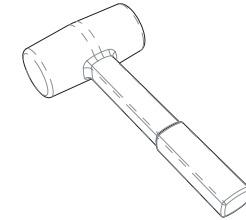

Rubber Mallet



Grease

We strongly advise that this bottom bracket is installed and maintained by a competent cycle mechanic, using Hope Bottom Bracket Tool (HTTFFA). This bottom bracket is intended for installation in bottom bracket shells with an internal diameter of 41mm and widths of 86.5mm, 89.5mm or 92mm. Check internal edges of bottom bracket shell and remove any burrs or paint build-up prior to fitting.

BBPF41SSN - Press Fit 41mm Bottom Bracket (Stainless Steel)
BBPF41CRN - Press Fit 41mm Bottom Bracket (Ceramic)

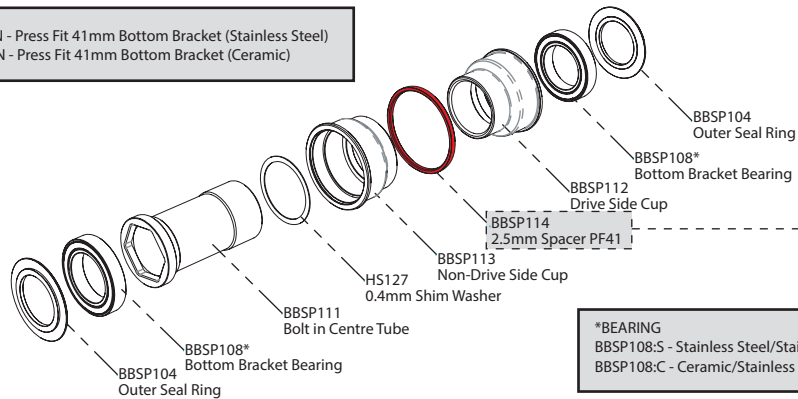

*BEARING
BBSP108:S - Stainless Steel/Stainless Steel
BBSP108:C - Ceramic/Stainless Steel

1. Measure the bottom bracket shell width to determine spacer usage.

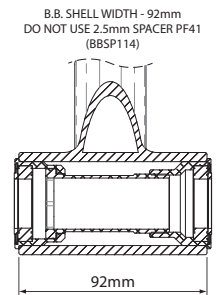
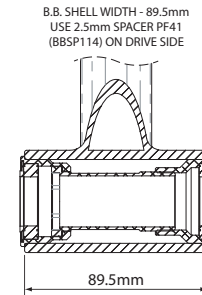
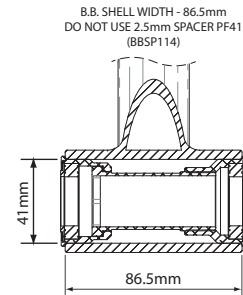

2. Install the drive side cup (with bearing fitted).

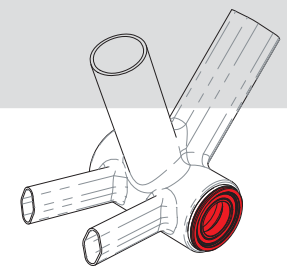
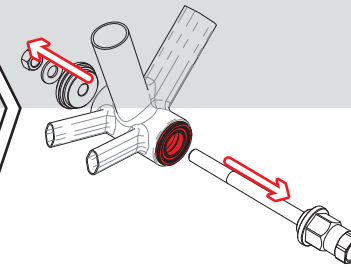
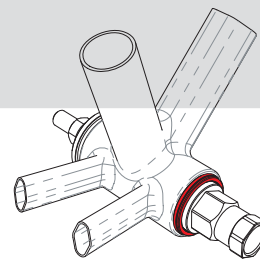
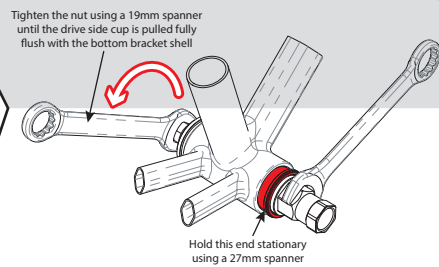
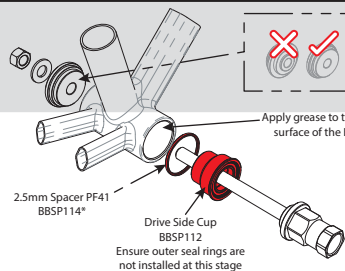

*Only install 2.5mm spacer PF41 (BBSP114) on 89.5mm shell width

3. Install the non-drive side cup (without bearing fitted).

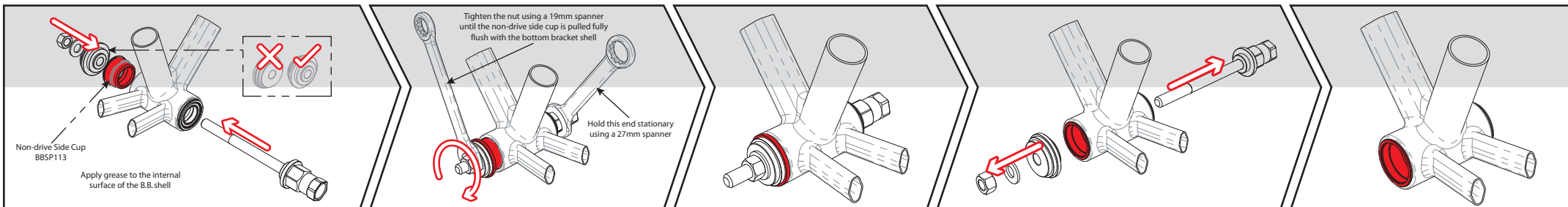

4. Install the centre tube, with 0.4mm shim washer.

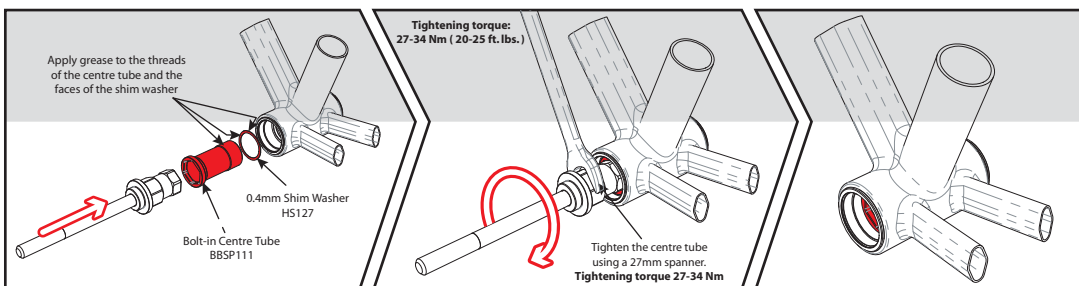

5. GXP conversion only.

If using a GXP style crank set, press one half of the GXP conversion (BBSP109 - available separately) into the INNER face of the non-drive side bearing (alternatively, gently tap into place with a rubber mallet). Do not install the other half of the GXP conversion at this stage.

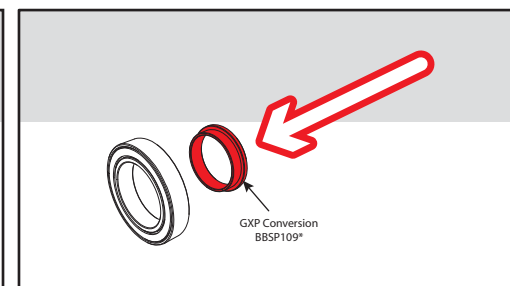

6. Install the non-drive side bearing.

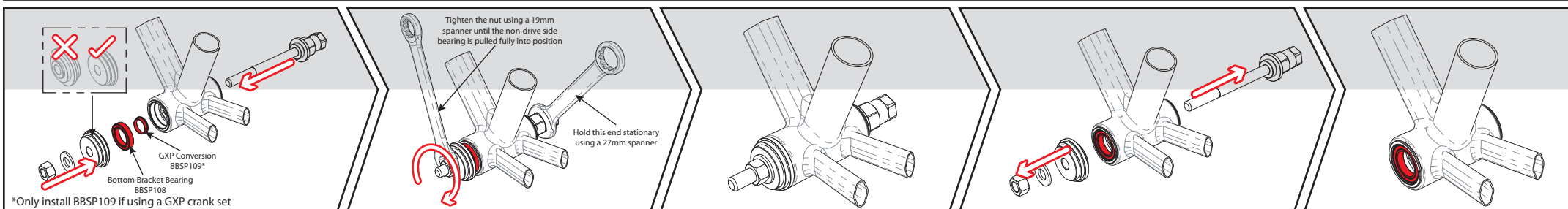

7. Install non-drive side outer seal ring.

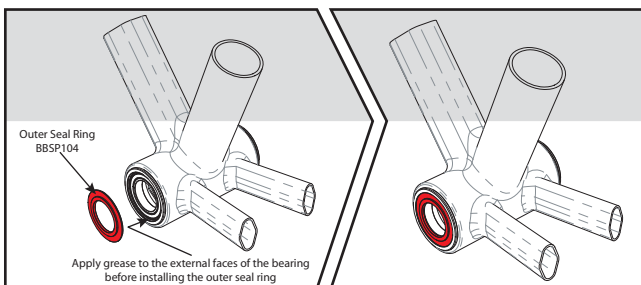

8. GXP conversion only.

If using a GXP style crankset, press the second half of the GXP conversion (BBSP109 - available separately) into the OUTER face of the non-drive side bearing, trapping the outer seal. Hope Bottom Bracket Tool (HTTTPFA) can be used to install this outer GXP conversion, but it must be done before installing the drive side outer seal ring.

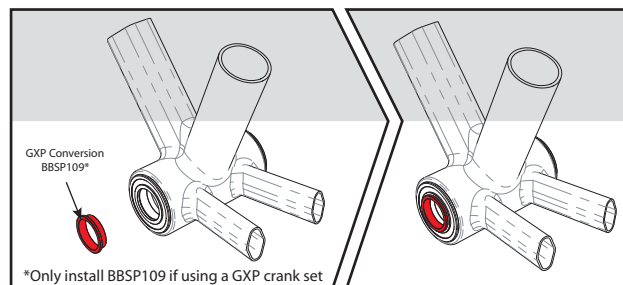

9. Install drive side outer seal ring.

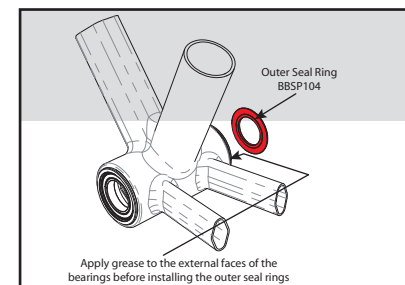

Your bottom bracket is now fully installed and ready for the continued installation of your crank set.