



2 LED

RECHARGEABLE LI-ION LED LIGHTING SYSTEM



www.hopetech.com



INSTRUCTION MANUAL

SPECIFICATION

LUMEN OUTPUT	MAX POWER	WEIGHT	REGULATED LIGHT OUTPUT	THERMALLY MANAGED	BEAM ANGLE	BURN TIME	POWER LEVELS

INTRODUCTION

The VISION 2 LED is the ultimate in high performance LED cycle lighting. It combines 2 high power LEDs offering 480 lumens on max power with over two hours of burn time from the small 2600mAh Li-Ion battery pack.

Electronic thermal throttling techniques help to protect the longevity of the LEDs by monitoring the housing temperature and restricting the power when the light unit gets too hot, thereby protecting the LEDs from overheating and providing a highly efficient lighting system that will last for years to come.

SYSTEM COMPONENTS

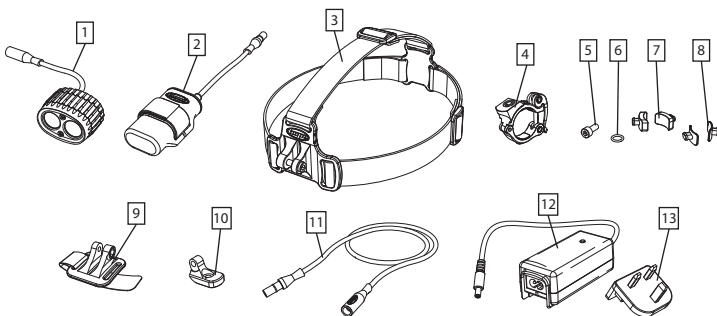

- | | |
|----------------------------------|----------------------------------|
| 1. 2 LED lamp unit | 8. 31.8mm handlebar sleeves (x2) |
| 2. Rechargeable battery pack | 9. Helmet mount |
| 3. Head Harness | 10. Helmet mount adapter |
| 4. Universal handlebar clamp | 11. Extension cable |
| 5. M5 x 12mm bolt | 12. Battery charger |
| 6. Handlebar clamp O-ring | 13. Exchangeable mains plug |
| 7. 25.4mm handlebar sleeves (x2) | |

IMPORTANT INFORMATION

Please take time to read these instructions before use in order to familiarise yourself with the operation of the lighting system. We strongly advise you read the following recommendations in order to prevent injury or damage to the lighting system.

WARNING

- This lighting system will withstand harsh wet weather conditions. However, it is not designed to be submersed in water. Please ensure that the light unit and battery pack are removed from the bike before washing - particularly if using a high pressure jet wash.
- Class 2 LED. Do not look directly at the beam. Permanent eye damage could result. Consider other people when mounting the light on a helmet to avoid dazzling them.
- Keep this light away from children.
- This light unit can get hot when in use in maximum power mode. This is normal and should not be mistaken as a malfunction. Please use with caution.
- Unlike many other LED lighting systems, this light unit will suddenly shut down after a period of time in low battery indicator mode without any dimming of the light. Please bear this in mind when riding at night.
- Use only the 7.4v Li-Ion battery pack supplied with the lighting system. Any attempt to use or charge another battery pack may result in explosion and serious injury.
- Do not short-circuit the battery terminals. This causes the battery to overheat and could result in fire or explosion.
- The battery charger is designed for indoor use only and should not come into contact with water.
- The battery charger contains dangerous voltages and the cover should not be removed. Any attempt to open the charger will invalidate the warranty.
- This light unit conforms to the requirements of EC directive 2004/108/EC for electromagnetic compatibility.

FITTING INSTRUCTIONS

UNIVERSAL HANDLEBAR MOUNT

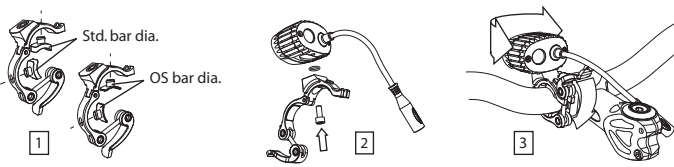

1. Select appropriate rubber plugs for your bar size and insert into location holes in the handlebar mount.
2. Attach mount to the light unit using the supplied M5 x 12mm bolt ensuring that the o-ring is located in the groove in the mount.
3. Attach mount to handlebar as close to the stem as possible and lock in place with the quick release lever. Adjust the direction of the beam as required (up to 20° max adjustment).

HELMET MOUNT

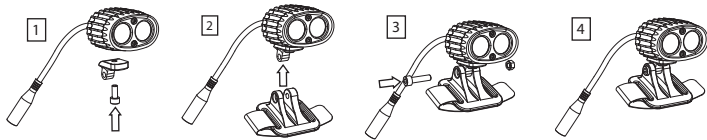

1. Attach the mount adapter to the light unit using the supplied M5 x 12mm bolt.
2. Slide the helmet mount over the mount adapter and align the bolt holes.
3. Secure in place using the supplied M5 x 20 bolt and locknut whilst ensuring there is just enough freedom to adjust the tilt angle while riding if required.
4. Attach the mount to your helmet using the hook and loop strap.

HEAD MOUNT

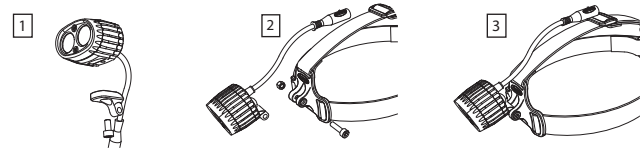

1. Attach the mount adapter to the light unit using the supplied M5 x 12mm bolt.
2. Slide the helmet mount over the mount adapter and align the bolt holes.
3. Secure in place using the supplied M5 x 20 bolt and locknut whilst ensuring there is just enough freedom to adjust the tilt angle while riding if required.

CHARGING THE BATTERY PACK

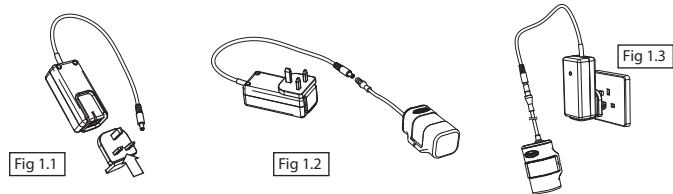

DANGER: Use only the 7.4v Li-Ion battery pack supplied with the lighting system. Any attempt to use or charge another battery pack may result in explosion and serious injury.

The battery charger is designed for indoor use only and should not come into contact with water.

The mains socket should be easily accessible. In the event of any operational error the plug should be immediately removed from the mains supply. The battery charger contains dangerous voltages and the cover should not be removed. Any attempt to open the charger will invalidate the warranty.

NOTE: The rechargeable battery pack is supplied with a small charge for testing purposes only. Therefore, it is recommended that the battery pack be fully charged before first use.

To correctly charge the battery pack, ensure these steps are followed in order:

- Insert the appropriate exchangeable mains plug into the charger (Fig 1.1)
- Disconnect from the light unit by pulling apart the two mating dc connectors. Never disconnect the battery from the light unit by pulling the cables. Always use the connector strain relief for grip when disconnecting (see Fig 2.).
- Before connecting the charger to the mains supply, plug the charger into the battery pack (Fig 1.2).
- Once the battery pack is connected to the charger it may then be plugged into the mains power supply (Fig 1.3). The charger's led indicator will show as orange when a discharged battery is connected, changing to green when fully charged.
- When charging is complete, disconnect from the mains before disconnecting the battery pack from the charger.

Charge Times

A fully discharged 2400mAh battery should take approximately three hours to fully recharge. This time will decrease if the battery was not fully discharged when placed on charge.

OPERATION OF THE LIGHT UNIT

With the light off:

- Press 1 – Turn light on in low power mode
 - Press 2 – Switch light into medium power mode
 - Press 3 – Switch light into high power mode
 - Press 4 – Switch light into max. power mode
 - Press 5 – Switch light into flash mode.
- Continue to cycle through power modes upon each press of the switch.
- Press and hold for 2 seconds to turn light off.

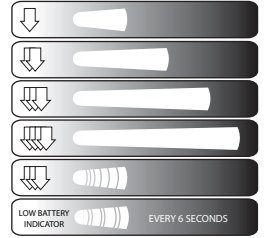

NOTE: We recommend that you utilise the full range of power modes during use in order to get the maximum burn time out of the battery, ie. Restrict your use of the maximum power level to a minimum and switch back down to a lower power level when you can.

Low Battery Warning

The light will automatically switch into a low battery warning mode upon detection that the battery voltage has dropped to a low level.

This will cause the light to automatically drop into low power mode (from whichever power mode the light was previously in) and blink twice approximately every 6 seconds.

We recommend that when the light switches into low battery indicator mode you either replace the battery pack with a fully charged spare (if you are carrying one), or take appropriate action to end your ride safely before the light switches off.

CAUTION: Unlike many other LED lighting systems available, this light will suddenly switch off without any dimming of the LED after approximately 30 minutes in low battery warning mode (depending on environmental conditions). Please bear this in mind when riding at night.

BURN TIMES

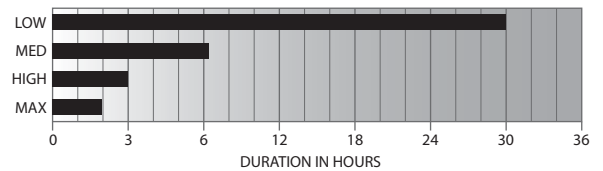

*Burn times stated have been tested in optimum conditions and may therefore vary from those times shown

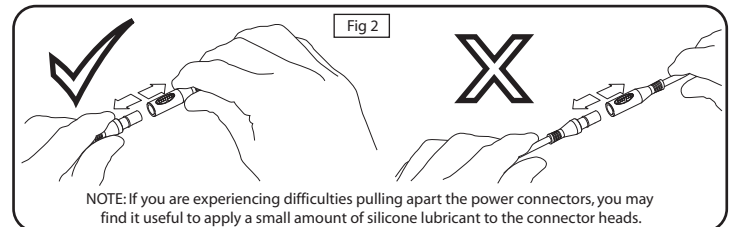

NOTE: If you are experiencing difficulties pulling apart the power connectors, you may find it useful to apply a small amount of silicone lubricant to the connector heads.

TRANSPORTATION AND STORAGE

Never carry the lighting system by the cable. This could result in damage to the electrical connections and will invalidate your warranty.

The ideal condition to store your Li-Ion battery pack is unplugged from the light unit - in a cool, dark environment with around half capacity charge. Never leave the battery pack over a long period (ie. the summer months) fully discharged.

MAINTENANCE

There are no serviceable parts inside either the light unit or battery pack. Please do not attempt to disassemble the units, as this will invalidate the warranty. If you find that there is a problem with the functioning of the lighting system please first check that the battery pack is fully charged (see Charging the Battery Pack section). If the light still fails to function please contact Hope Technology.

WARRANTY

All Hope Technology lighting systems are covered for one year from original date of purchase against manufacturer defects in material and workmanship. Proof of purchase is required. Product must be returned to Hope Technology to process any warranty claim.

This warranty does not cover any damage caused through mis-use or failing to comply by the recommendations given in this manual.

This warranty does not affect your statutory rights.